

Calculemus!

Berechnen wir!

Leibniz



1646 – 1716

- ◆ Droomde van de “**Calculus ratiocinator**”
 - ✦ Een logisch denkend apparaat

Waarmaken van Leibniz's droom

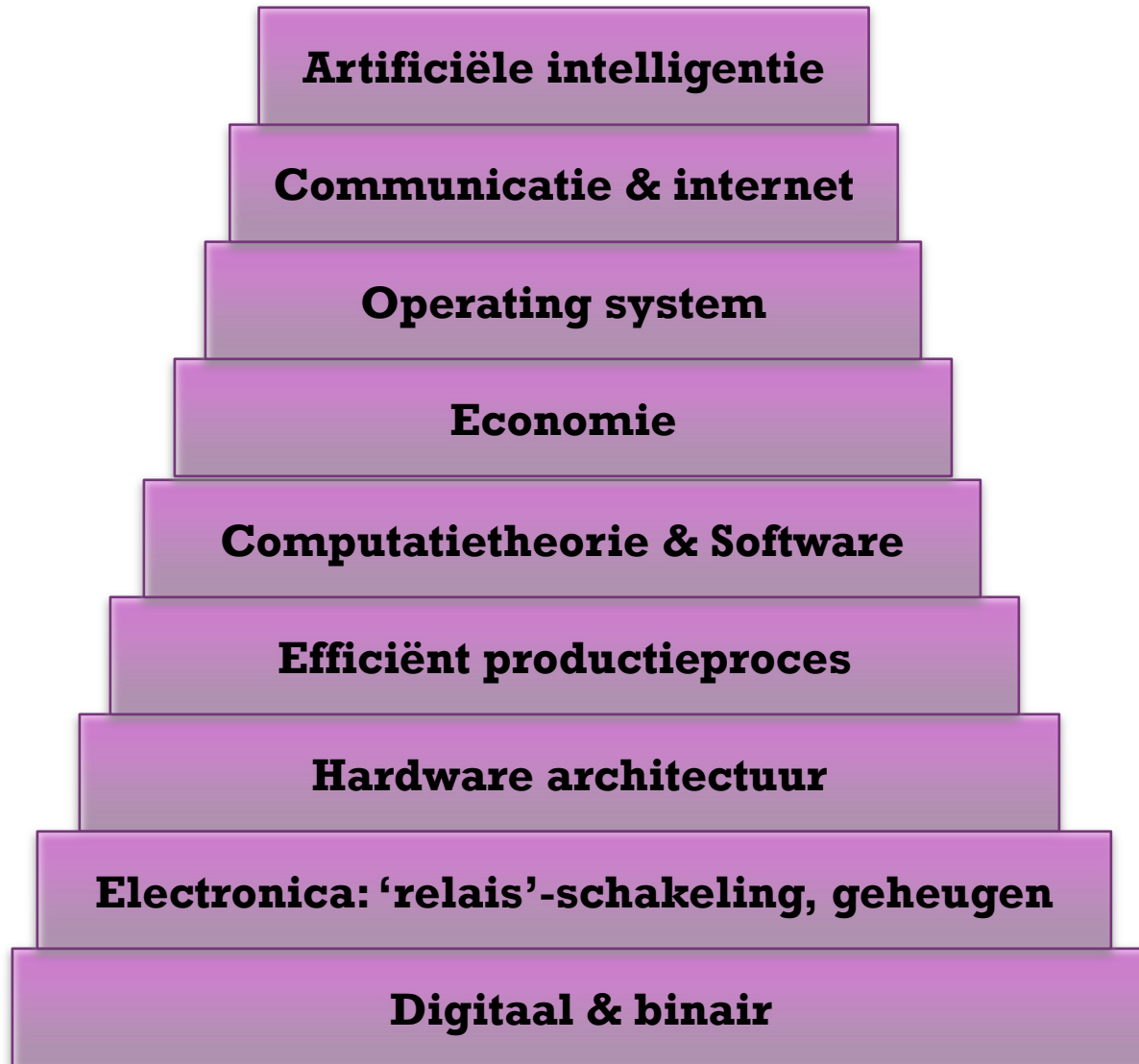

Eerste computer, mechanisch

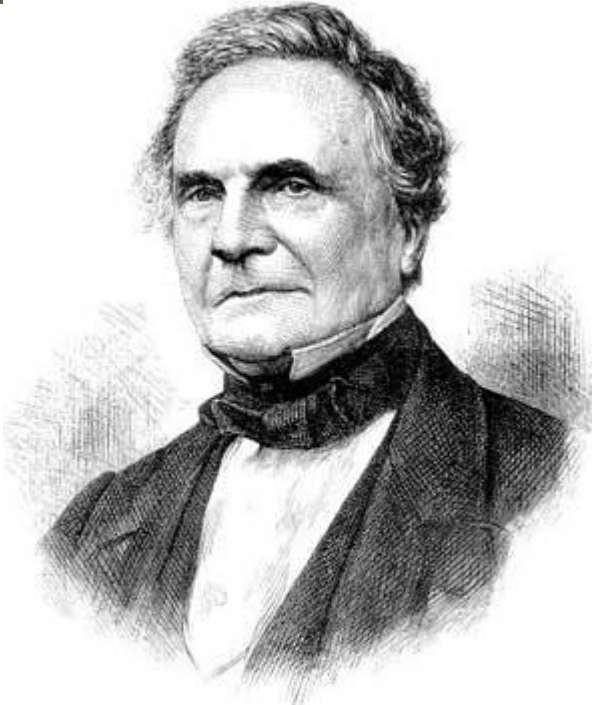

Charles Babbage
1791-1871



Babbage Difference Engine made with LEGO

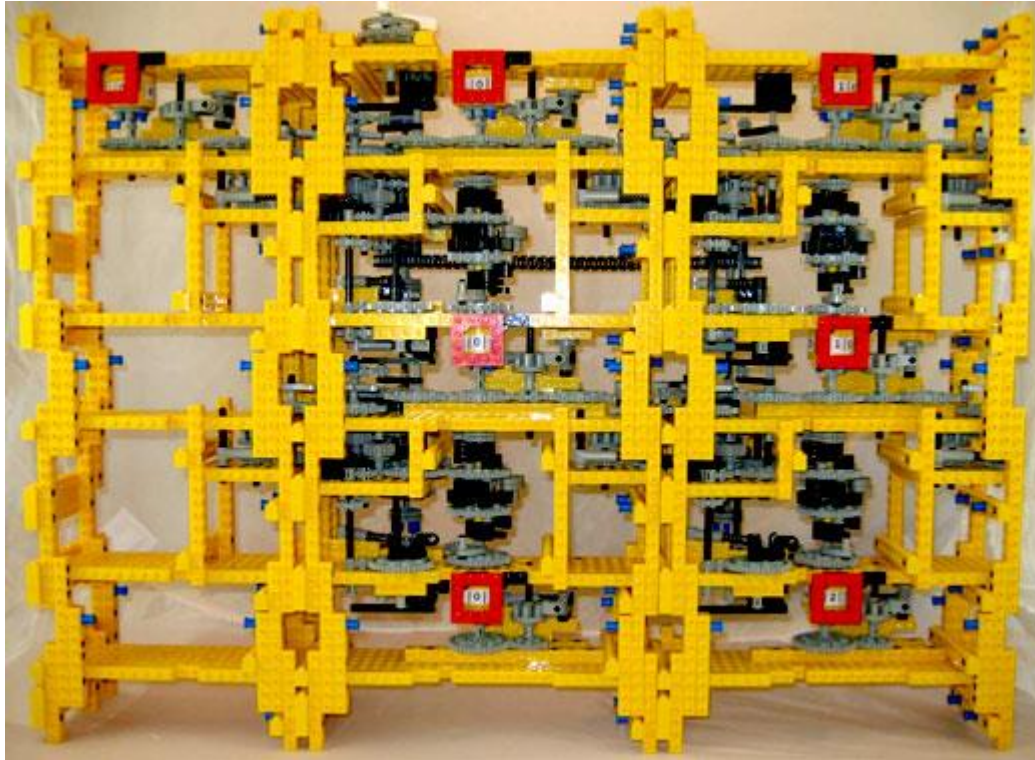

◆ <http://acarol.woz.org/>

This machine can evaluate polynomials of the form $Ax^2 + Bx + C$ for $x=0, 1, 2, \dots, n$ with 3 digit results.

De eerste informaticus



Ada Lovelace
1815 – 1852

- ◆ Beschrijft wat software is
 - ✦ Ze ziet in dat je meer kan doen met een computer dan enkel berekenen
- ◆ Schrijft eerste algoritme/programma

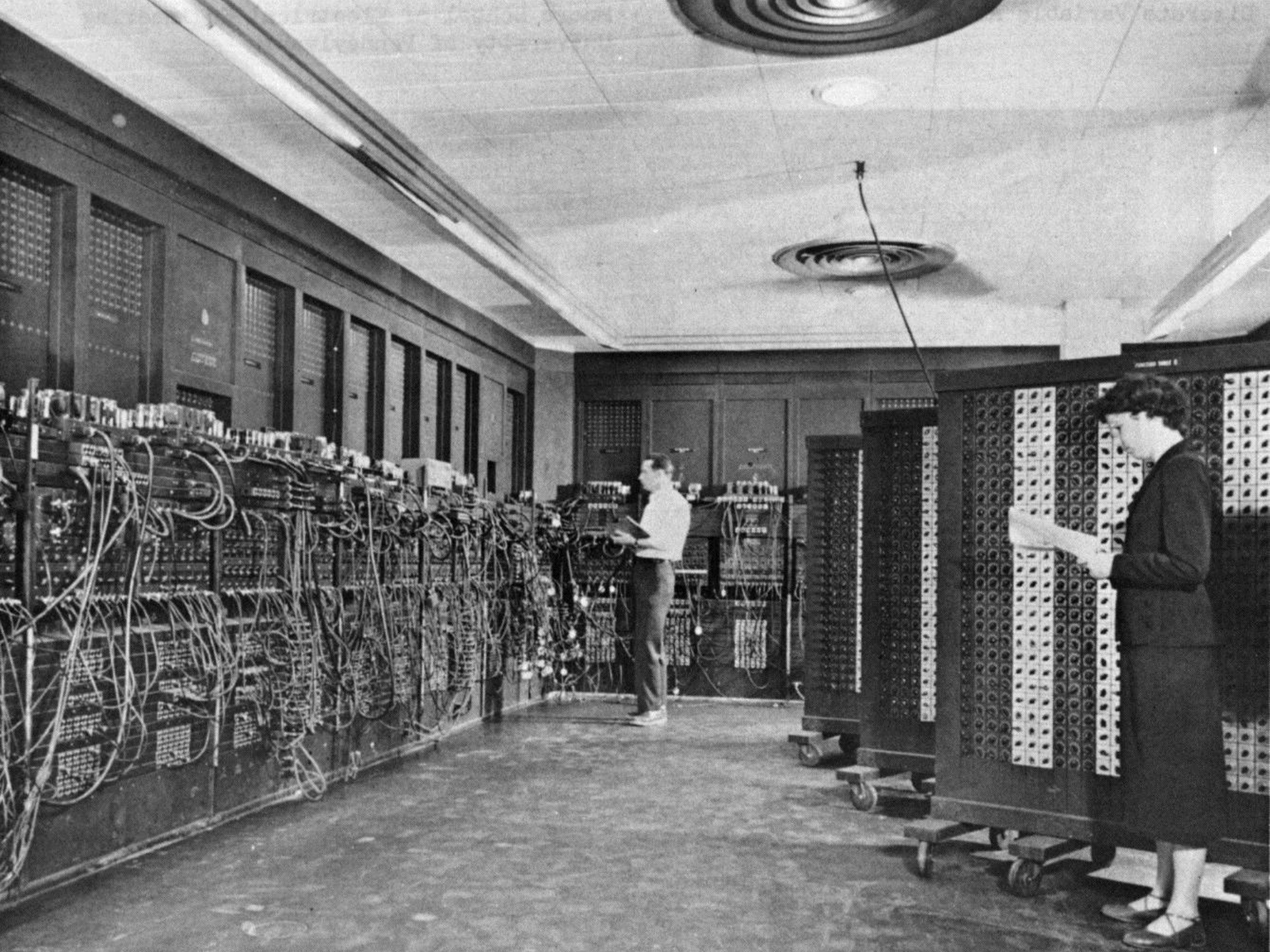

ENIAC

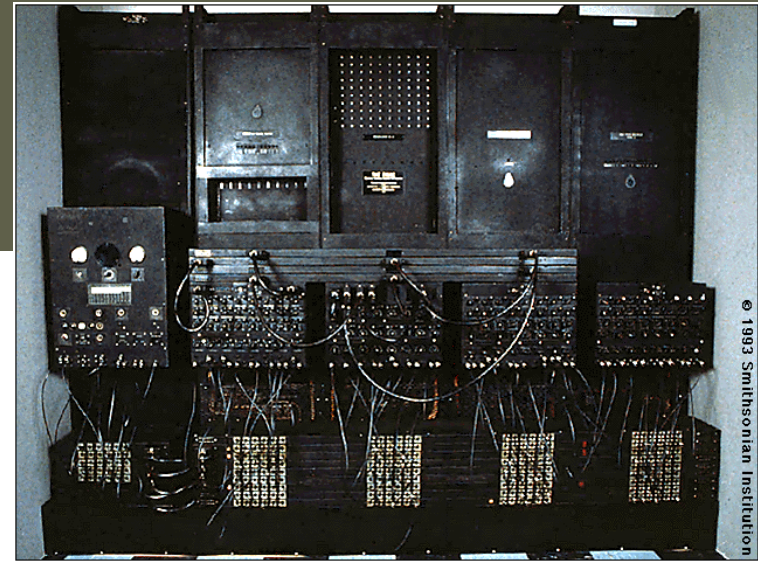
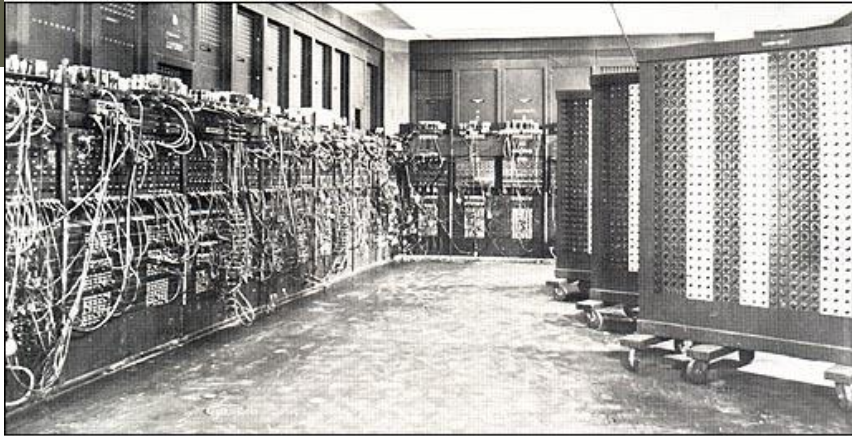

Eerste computer: WOII





John Atanasoff
1903 – 1995



Clifford Berry
1918 – 1963

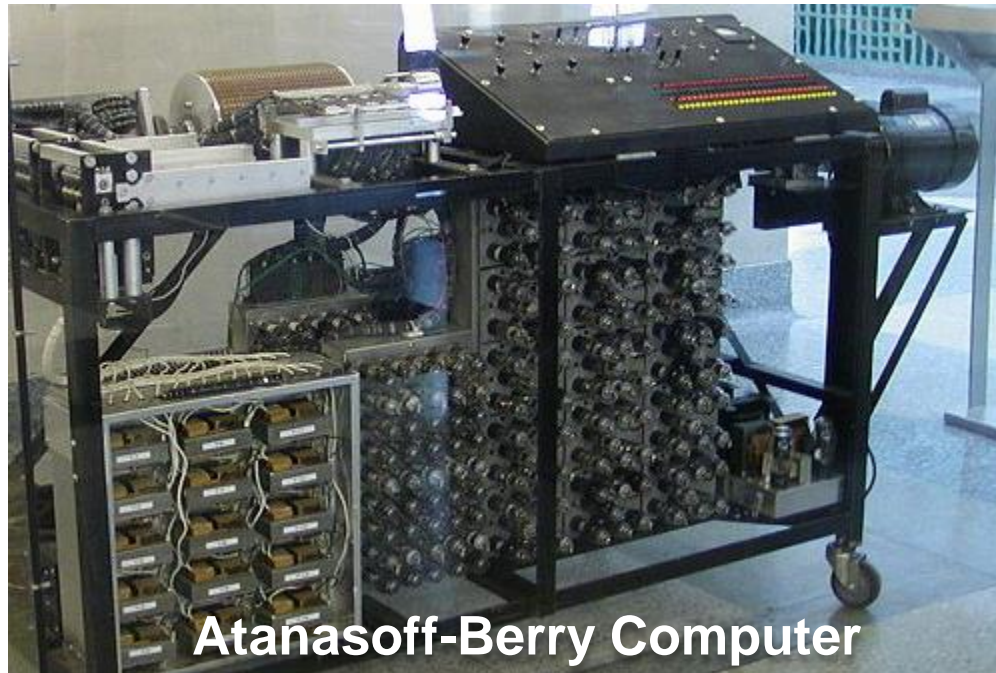

Atanasoff-Berry Computer

Honeywell v. Sperry Rand case, 1973



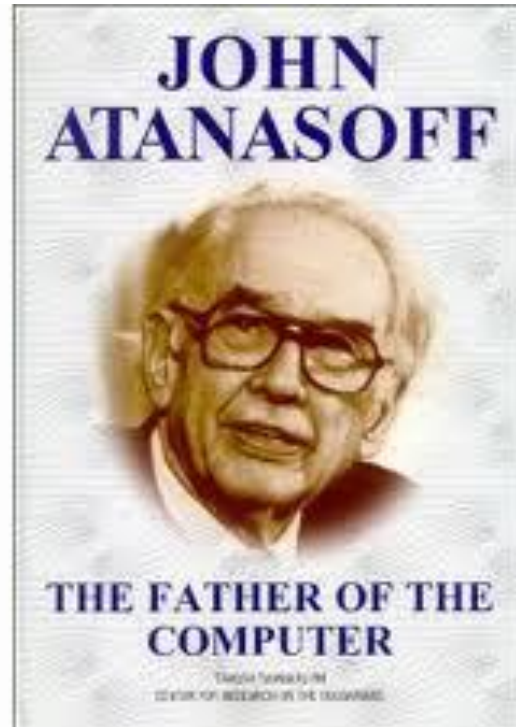

Was dit de eerste electronische computer?

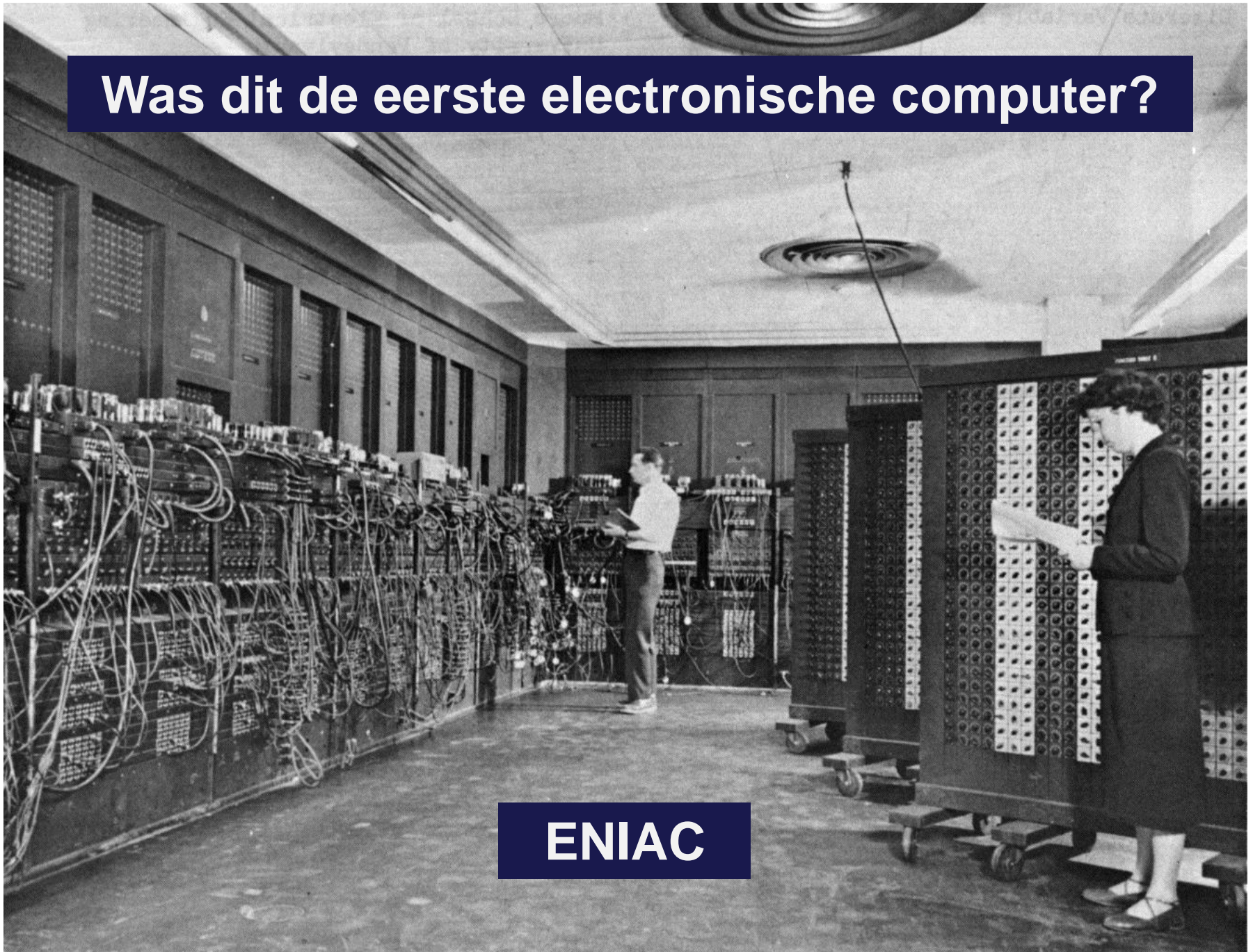

ENIAC



Winston Churchill



Bletchley Park



Op zoek naar "cribs"



De Enigma code

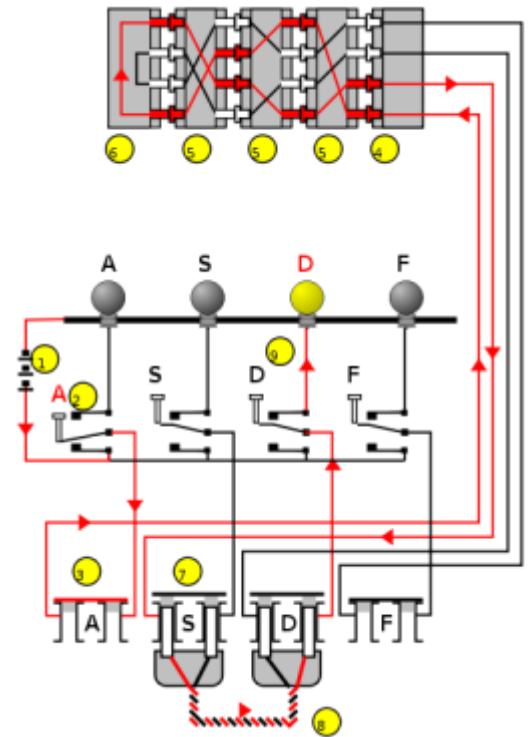

Colossus: the first operational electronic computer

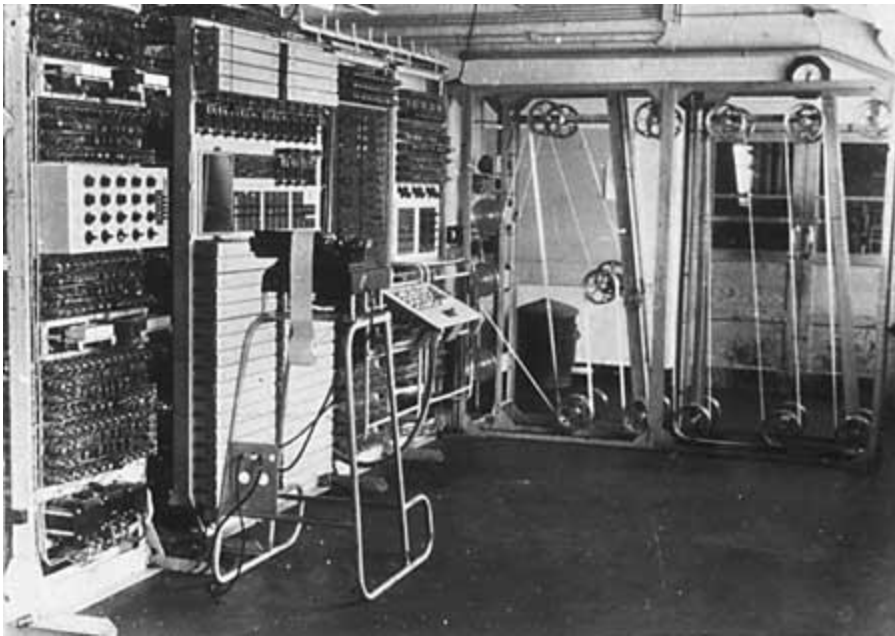

Alan Turing
1912-1954